

Verti-Block® Retaining Walls

Hollow, interlocking blocks

Sized for residential and
commercial use

Innovative engineering for
unparalleled strength

Easy installation with
smaller equipment

A beautiful, cost-effective
earth retaining solution

Right look.
Right strength.
Right size.



Nothing stacks up quite like Verti-Block.



When you need a solution for retaining walls and other landscape projects, nothing stacks up quite like Verti-Block. Unique in size, shape, and flexibility of use, Verti-Block is an ideal solution for residential and commercial projects alike.

Unique size and design

A hollow block measuring 2' x 4' x 3', Verti-Block is perfectly proportioned for the most popular types of landscaping projects, including gravity walls up to 12' high—even higher when reinforced. Its hollow design makes it affordable and easier to handle than solid blocks. Plus, Verti-Block is less labor intensive than small, hand-laid blocks and offers a more practical solution than a cast-in-place retaining wall.

Interlocking Verti-Blocks

Verti-Block interlocks with a unique male-and-female design. You'll get unmatched strength with more flexibility for landscape applications.

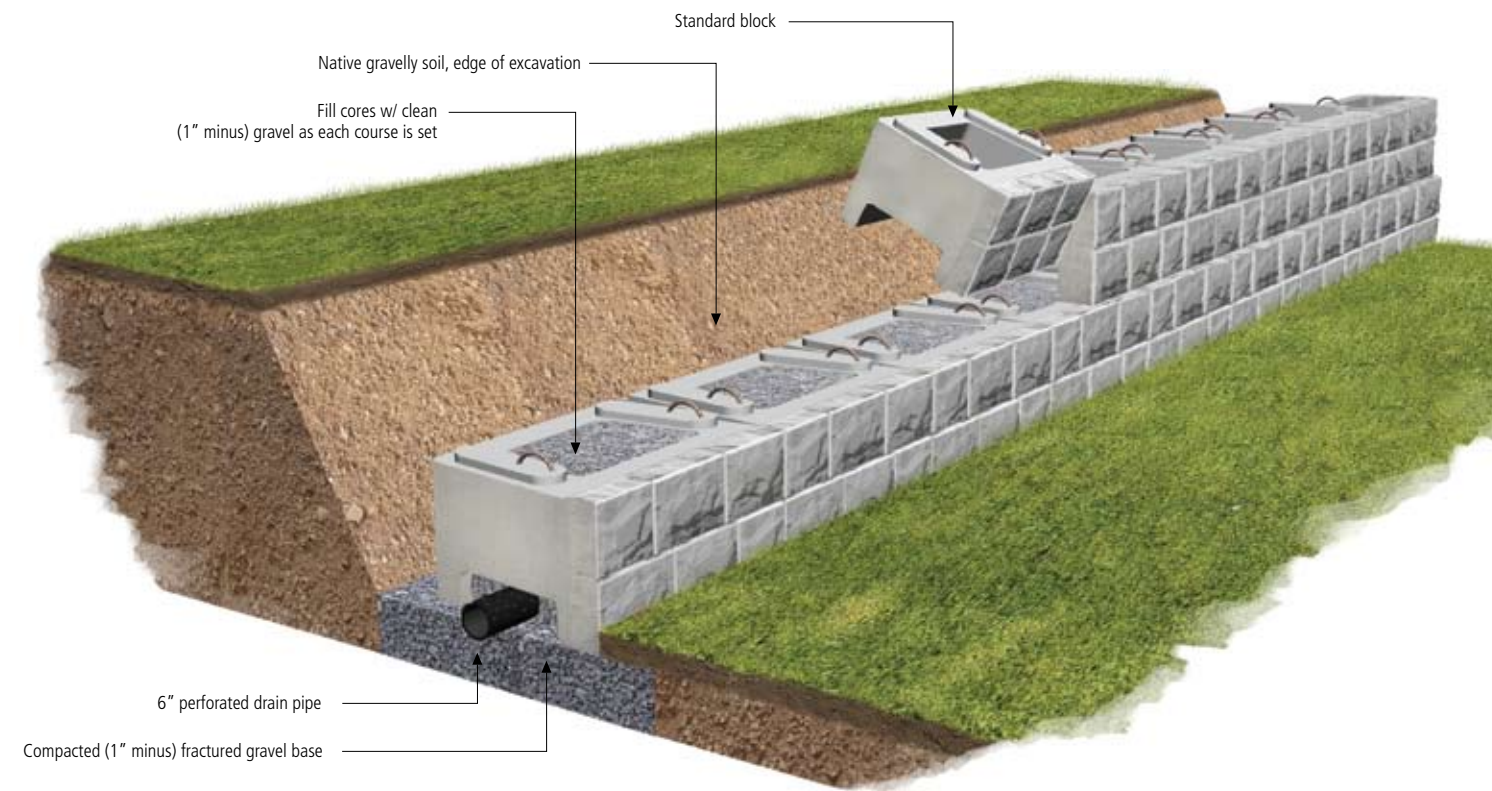

Strong and versatile

Even more appealing, Verti-Block is incredibly strong and versatile thanks to its interlocking design. Featuring a male-and-female style connection, Verti-Block units ensure you'll get a secure fit that guarantees the correct amount of setback on every installation. Verti-Block's hollow design saves money by using less concrete and lowering transpiration costs. It also ensures the right amount of gravel backfill. Experienced installers know that too much gravel wastes money—too little can build hydraulic pressure and cause the retaining wall to fail.

Easy installation

Verti-Block was created with landscaping in mind—meaning we've made it easy to transport and install, even in tight access spots. Blocks can be moved and put into place with smaller equipment; there's no need for heavy machines like a telehandler or crane. The male-and-female connection eliminates placement error, ensuring strength and an exact installation every time.

Verti-Block Walls

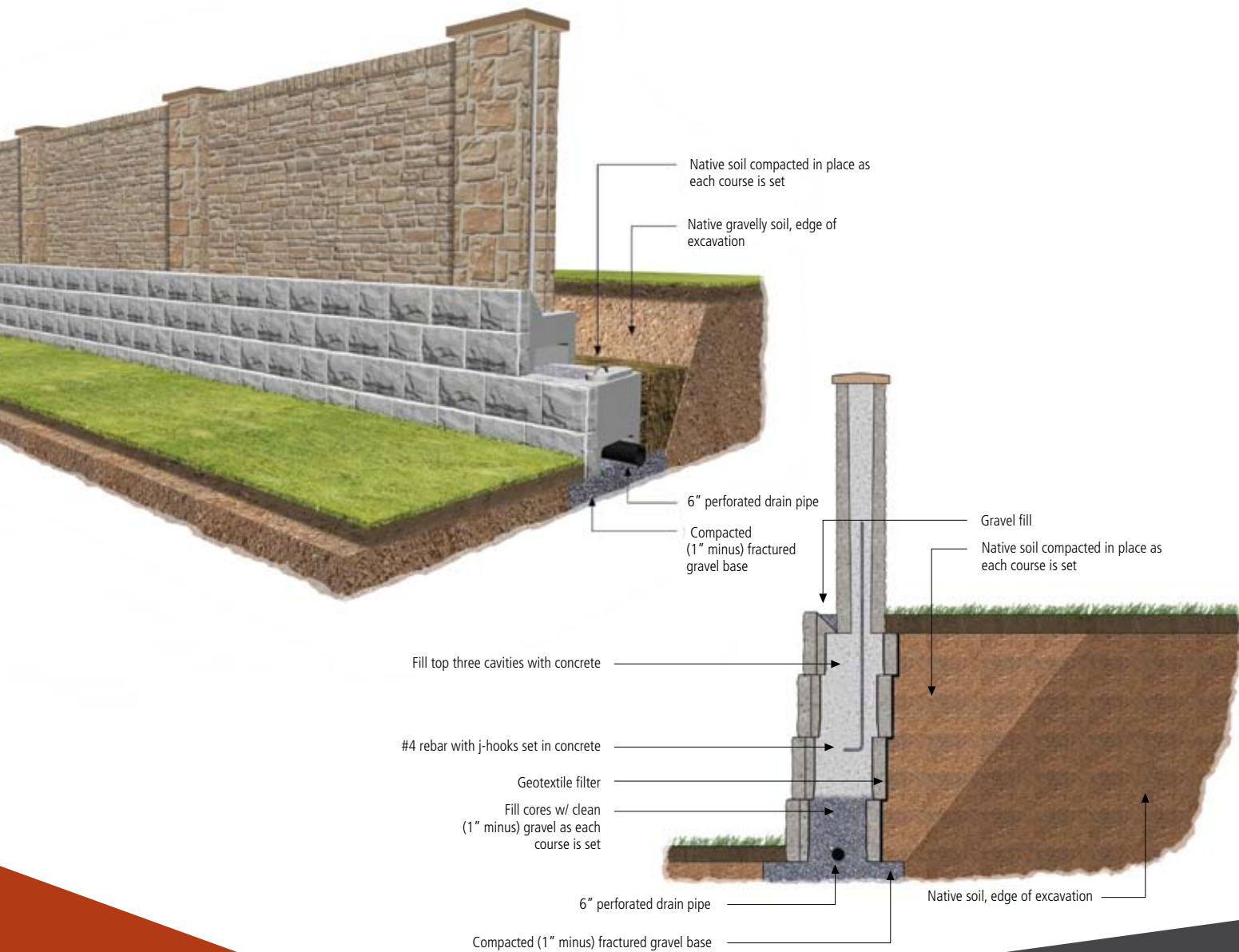

Convex and Concave Verti-Block Walls

The interlocking nature of Verti-Block allows you to create curves while remaining structurally sound.

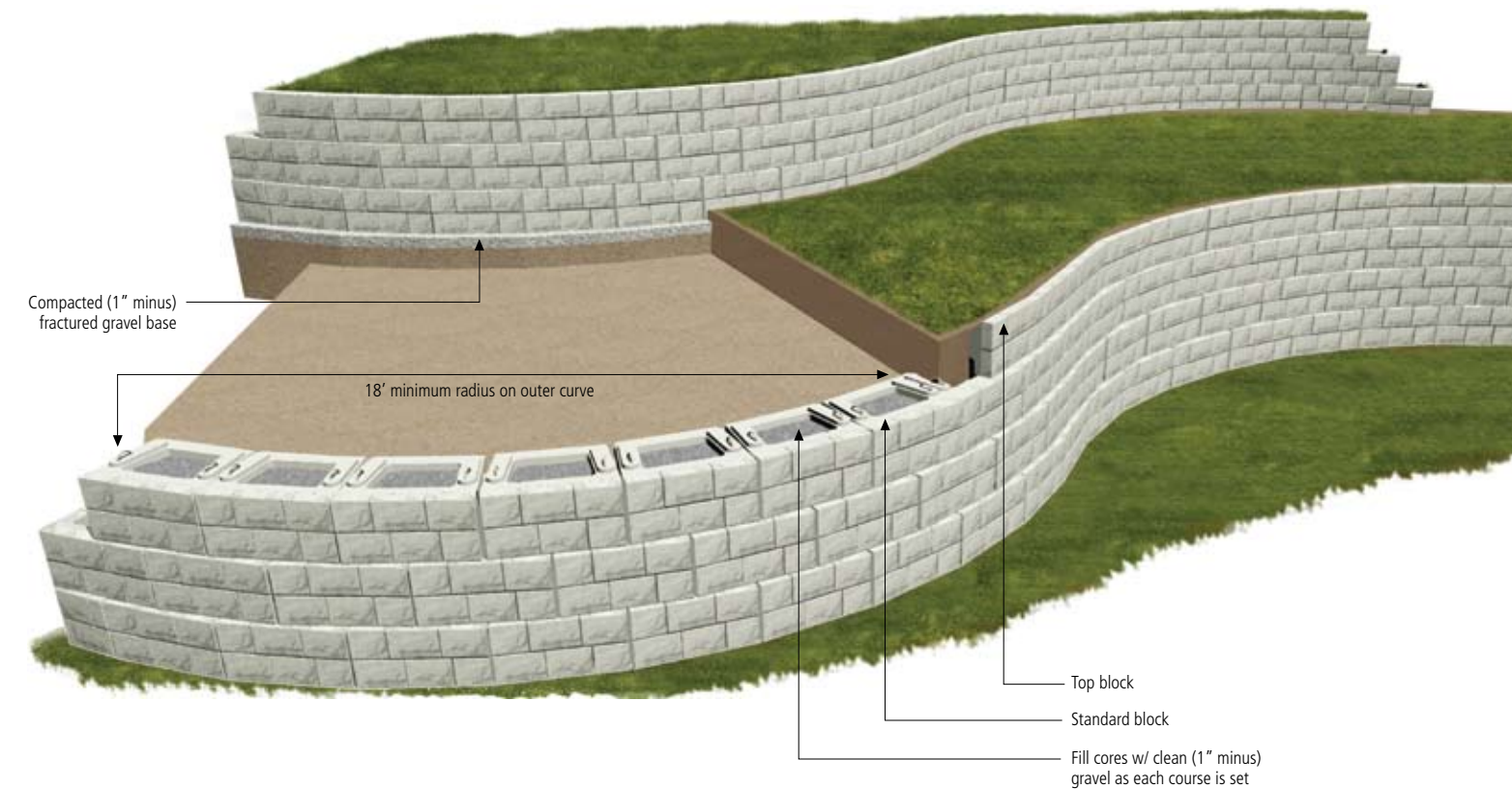

A look like no other

Beyond its structural purpose, Verti-Block is a favorite of property owners for its beautiful rockwork look. Verti-Block showcases a 5-inch depth of relief, hiding joints, and making a finished wall appear more like stacked stone. Plus, Verti-Block is easily stained to complement its surroundings with a beautiful, weather and UV-resistant finish.

Perfect for landscape projects big and small

Verti-Block is ideal for a variety of landscaping projects including residential communities, commercial campuses, schools, parks, back yards, and more. Able to accommodate winding landscapes and even tight curves, Verti-Block is designed to add interest to any landscape while securely retaining earth.

For projects also requiring a privacy wall, Verti-Block allows fencing or walls to be constructed directly on top of the Verti-Block structure. Fencing can be placed right to the edge of the wall for an attractive, continuous appearance.

Consider Verti-Block for applications such as:

- ▶ Gravity walls
- ▶ Terracing
- ▶ Plantable retaining walls
- ▶ Base for fencing or railings
- ▶ Property dividers

Gravity Wall

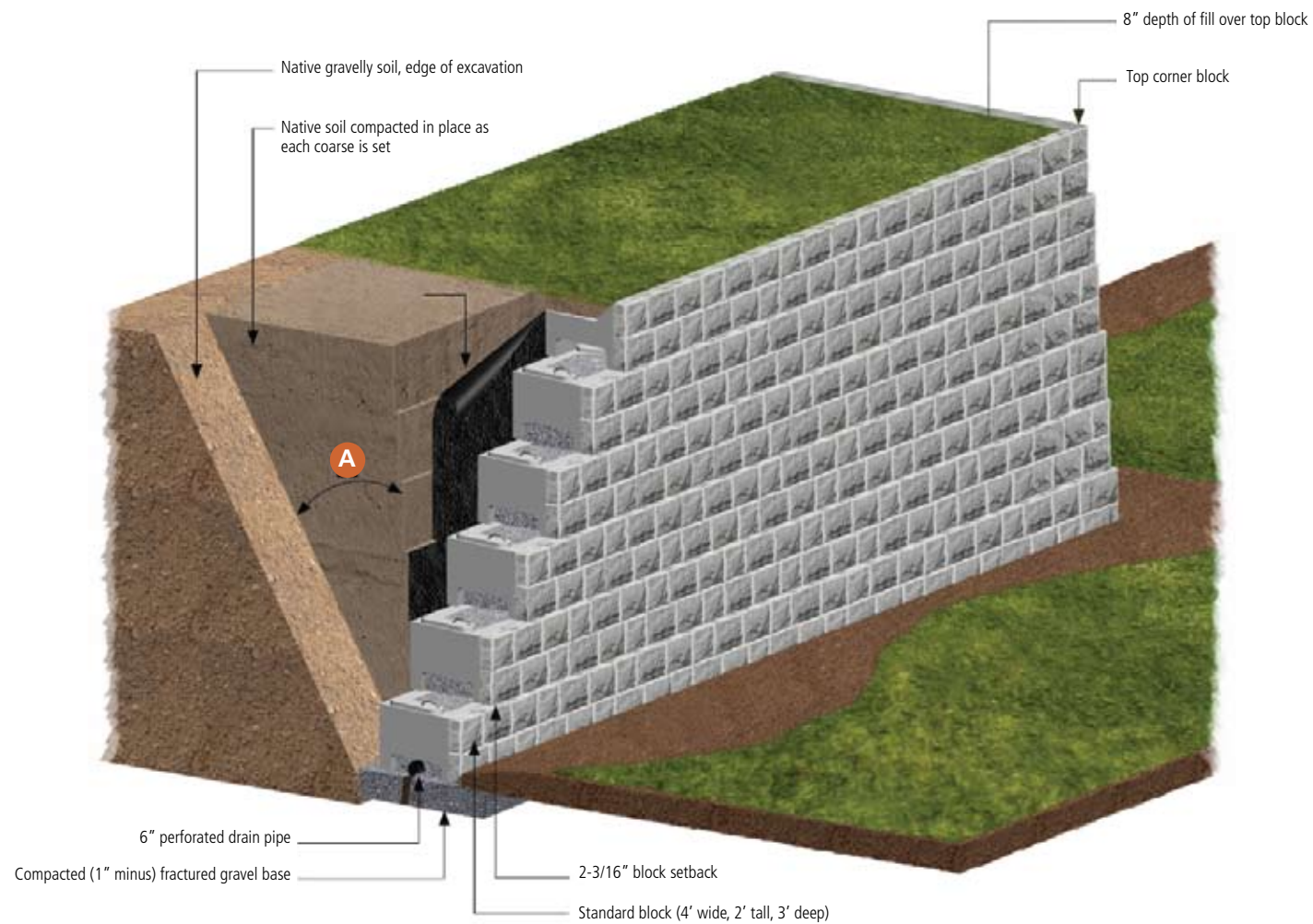

Reinforced Verti-Block Wall

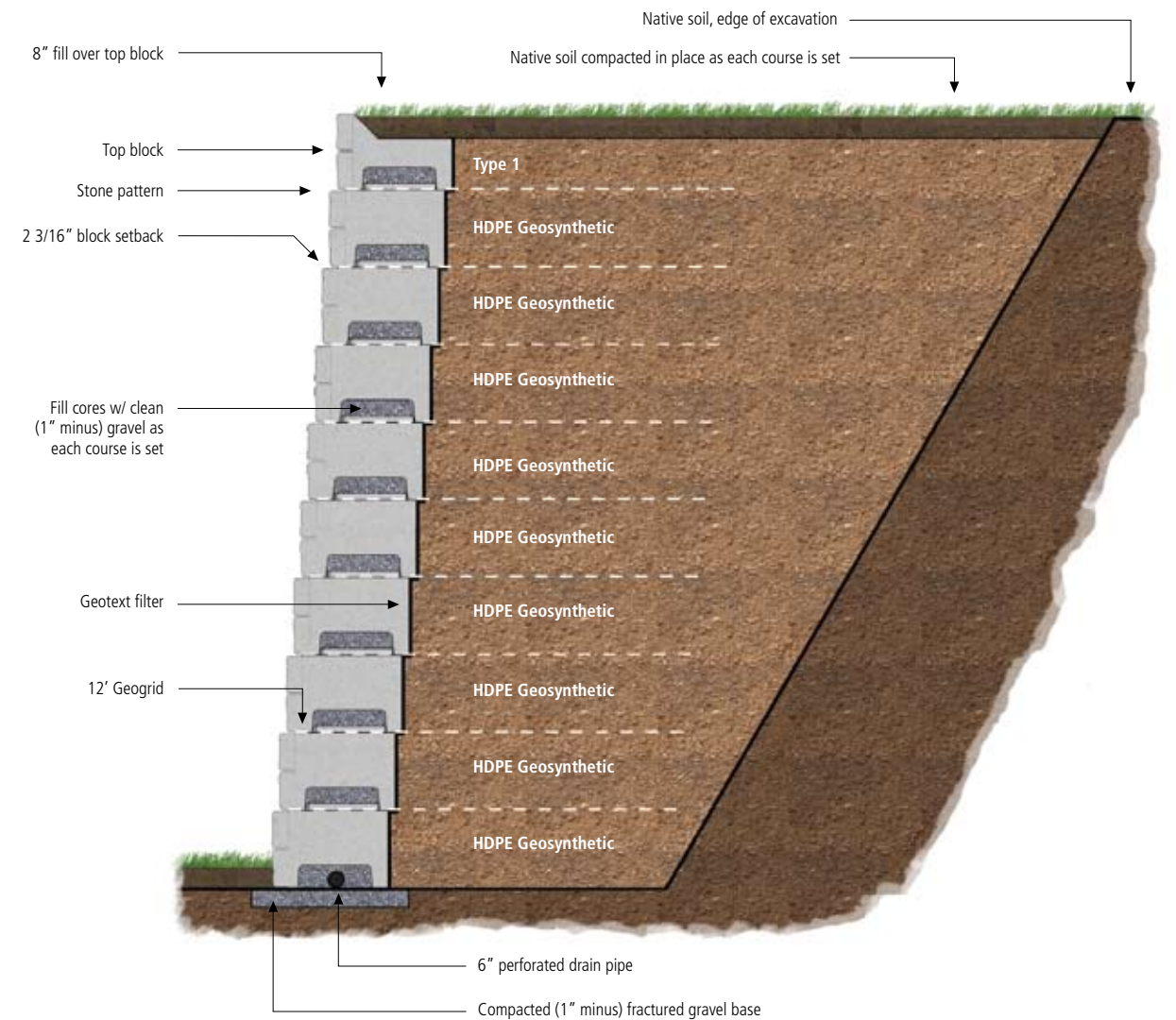

Maximum gravity wall height

A	Wall Height	Soil Type
≥ 30°	8' (2.44 m) Wall	Silty
≥ 35°	10' (3.05 m) Wall	Sandy
≥ 40°	12' (3.66 m) Wall	Gravelly

Engineered for strength

While the hollow nature of Verti-Block makes it cost effective and easier to handle, it also improves its ability to retain earth. Even in poor soil conditions, Verti-Block can be stacked higher than other blocks without the use of tiebacks or geogrid.

The male-and-female design of Verti-Block adds a stronger connection than blocks relying on friction alone. The gravel fill also interlocks and creates a continuous mass for greater strength.

A cost effective solution

Best of all, Verti-Block delivers tremendous cost savings. As a hollow block, Verti-Block is lighter, requiring less manpower, equipment, and transportation costs. It's quick to install, and the product itself is less expensive to manufacture than solid block options. The internal drainage through the block's infill means no over-or under-excavating because no additional gravel backfill is required.

Property owners will appreciate the affordability and value of Verti-Block. Add that to the right look and right strength of this unique product, and you'll know Verti-Block is the right solution for a great landscape installation.

Property owners will appreciate the affordability and value of Verti-Block.

Verti-Block Units



Verti-Block is available in a range of shapes to accommodate all your landscape design needs

Standard Block

1800 lbs (816 kgs)

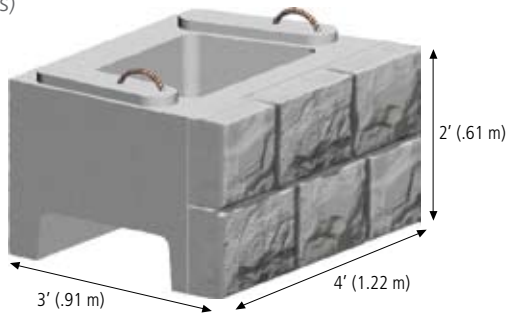

Top Corner Block

1550 lbs (702 kgs)

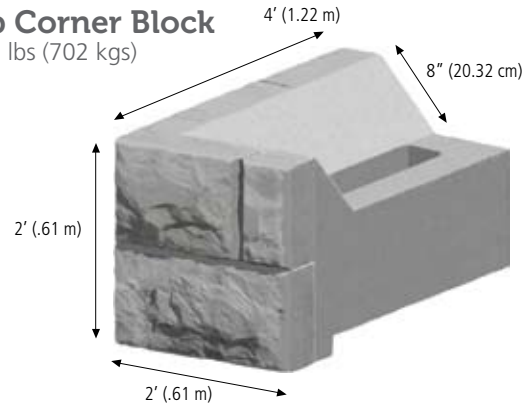

Corner Block

1700 lbs (770 kgs)

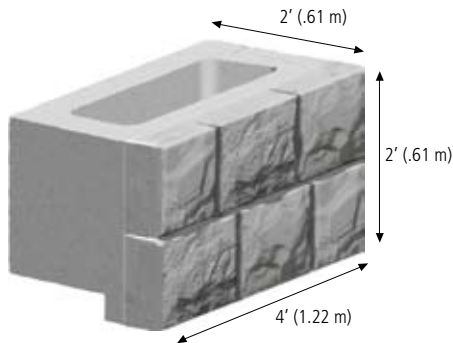

Top Block

1620 lbs (734 kgs)

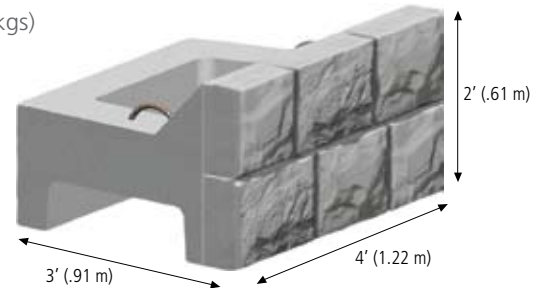

Half Block

900 lbs (408 kgs)

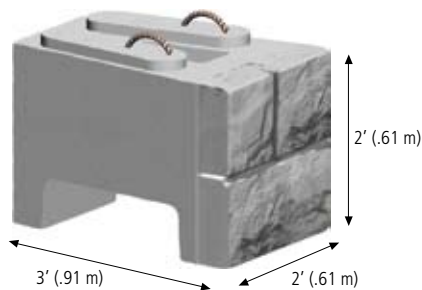

Half Top Block

800 lbs (362 kgs)

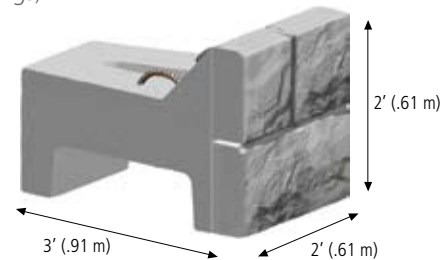

Mail

P.O. Box 2347
Sandy, UT 84091

Plant

16500 South 500 West
Bluffdale, UT 84065

Phone 801-571-2028

Fax 801-571-3486

Email sales@verti-crete.com

Web www.verti-crete.com

Verti-Block Units

Verti-Block is the latest innovative product from Verti-Crete, LLC. Recognized worldwide for outstanding aesthetics and a patented system that produces top-quality construction materials, Verti-Crete continues to help contractors, developers, and property owners with smart precast solutions.

Verti-Block may be purchased through a local, licensed Verti-Block manufacturer. Please call 801-571-2028 to find a producer near you.